

53

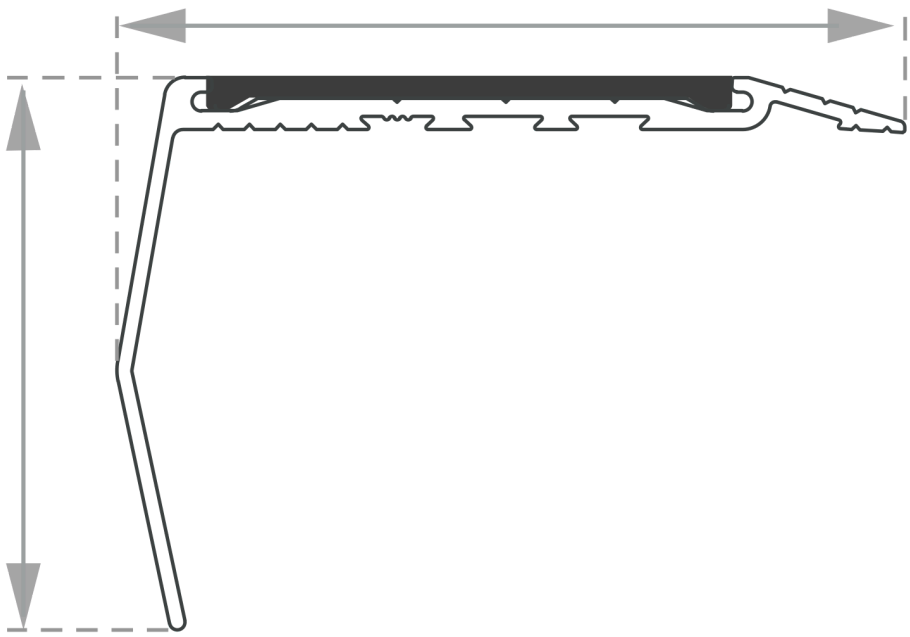

75